

SMART *Sliding*
& MORE





SOFT CLOSE MECHANISM **SLIDING DOORS**

BWAY Smart Sliding offers, pneumatics Soft Close Mechanism which is compact and slim. It is entirely hidden in the top track, giving the Sliding Doors clean and aesthetic appeal to it. These door bearings comes in different weight & capacities for different door sizes for smooth sliding experiences.

BWAY is designed to exceed the expectation of those who believe in a Quality & Lifestyle by Architects and Interior Designers, who know the know how with consolidated knowledge. Bway focuses on designing solution in tune with international quality standard and deliver them with timely manners with utmost perfection.

CONTENT

SMART *Sliding*

●	TELESCOPIC SOFT CLOSE SLIDING	4-7
●	SYNCHRO SOFT CLOSE SLIDING	8-9
●	TELESCOPIC + SYNCHRO SOFT CLOSE SLIDING	10
●	SOFT CLOSE SLIDING SYSTEM	
■	Single & Double Door	11-13
■	Invisible Sliding - 2106	14
■	Invisible Sliding - 2108	15
■	Pocket Sliding - 2107	16
●	PROFILES & SLIDING HARDWARE	17-21
●	movingwalls Perfect Sliding System 3/4/5 Door	22-23
●	MagTOUCH Electromagnetic Driver Intelligent Sliding System	24-26

SMART *Partition*

●	OUTER FRAMED DOOR PARTITION MINIMAL 45MM SERIES SYSTEM IN 6 COLOURS	27-31
●	LUXE-45 SERIES FRAMED DOOR WITH FLOOR SPRING	32-33
●	PARTITIONS HARDWARE & ACCESSORIES	34-35

SMART *Shower*

●	FRAMED SHOWER PARTITION WITH FRAMED DOOR	36-37
●	FRAMED SHOWER PARTITION WITH FRAMELESS DOOR	38

FRAMELESS SOFT CLOSE *Sliding*

●	ONE WAY & TWO WAY SOFT CLOSE SLIDING FRAMELESS DOOR	39
●	TELESCOPIC SOFT CLOSE SLIDING FRAMELESS DOOR	40-43
●	SYNCHRO SOFT CLOSE SLIDING FRAMELESS DOOR	44-45
●	TWIN PRO SYSTEMS	46-48
●	FRAMED DOORS	49
●	FRAMELESS DOORS	50

TELESCOPIC SOFT CLOSE SLIDING
1 FIX + 2 SLIDING DOOR



TELESCOPIC SOFT CLOSE SLIDING 1 FIX + 2 SLIDING DOOR

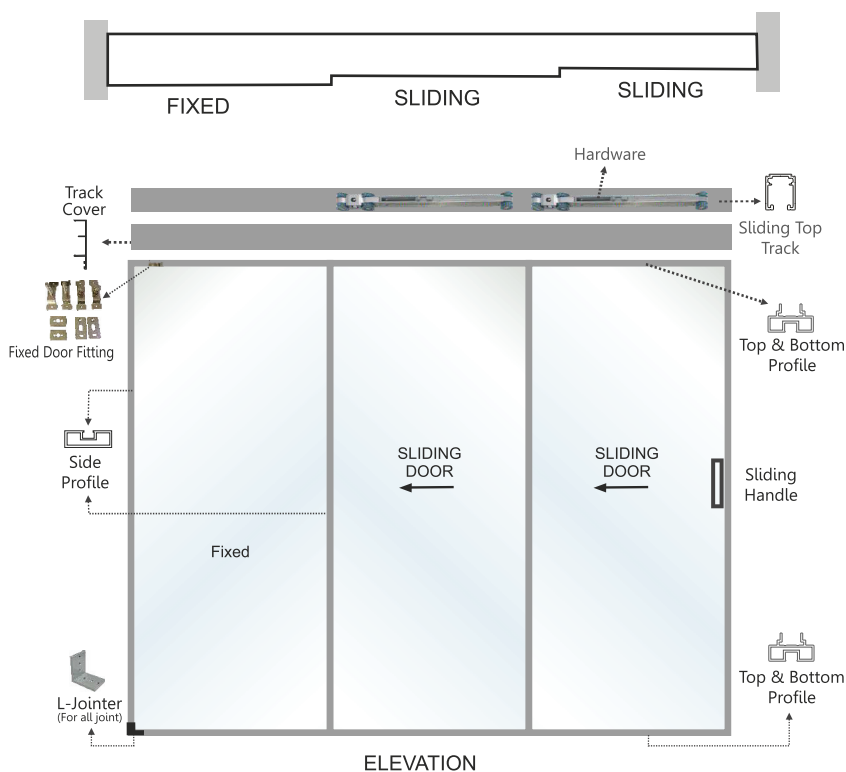

CONFIGURATION
1 FIX + 2 SLIDING DOOR

MAXIMUM WIDTH / HEIGHT
1200 MM / 3000 MM

WEIGHT LIMIT PER FRAME
120 KG

PROFILE FRAME FINISH / ANODISED
BLACK MATT / BRUSH GOLD /
CHAMPANGE / ROSE GOLD / DARK GREY

ALUMINIUM PROFILE SUITABLE FOR
8 MM / 10 MM GLASS

AVAILABLE WITH LOCK OPTION

HARDWARE



BWAY Telescopic Sliding Set - 1 Fix 2 Sliding Door
BWAY-TLS-1+2

PROFILES & ACCESSORIES

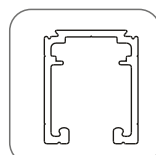

Sliding Top Track
BWAY-T1

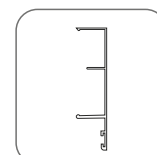

Track Cover
BWAY-TC-T1



Fixed Glass Clamp
BWAY-FGC-DF-01

4516-Series

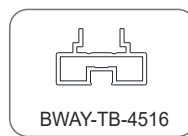

BWAY-TB-4516

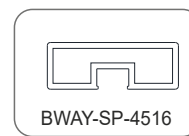

BWAY-SP-4516

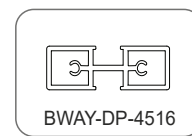

BWAY-DP-4516

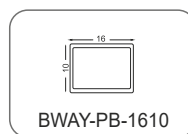

BWAY-PB-1610

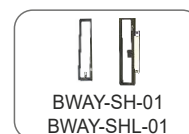

BWAY-SH-01
BWAY-SHL-01



BWAY-LJ-90-4516
BWAY-GASKET
4516-Plastic

4507-Series

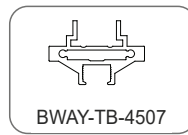

BWAY-TB-4507

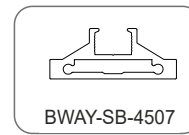

BWAY-SB-4507

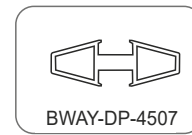

BWAY-DP-4507

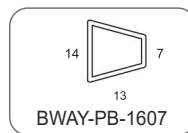

BWAY-PB-1607



BWAY-SH-02
BWAY-SHL-02



BWAY-LJ-90-4507
BWAY-GASKET
4507-Plastic

TELESCOPIC SOFT CLOSE SLIDING 1 FIX + 3 SLIDING and 1 FIX + 4 SLIDING DOOR

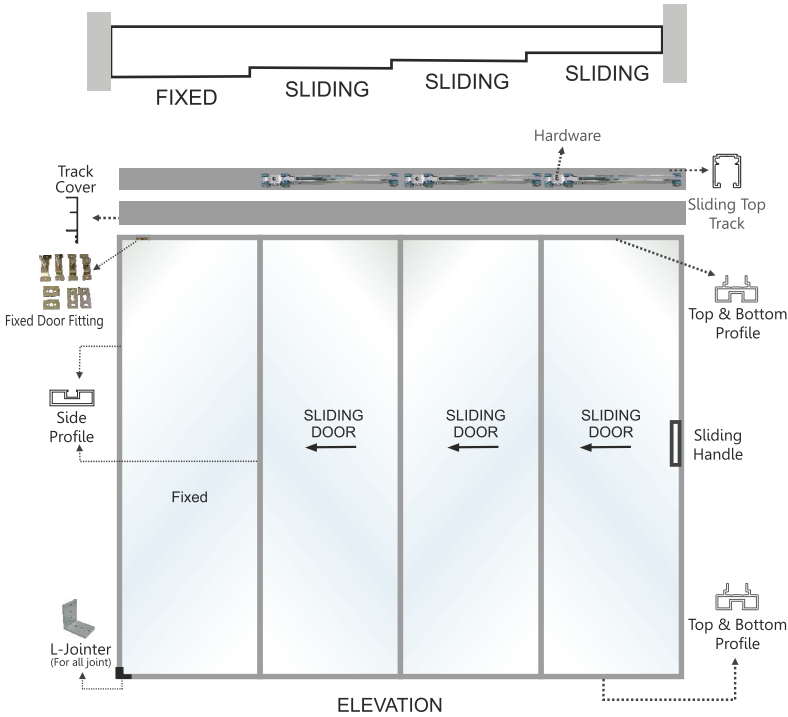

CONFIGURATION

1 FIX + 3 AND 4 SLIDING DOOR

MAXIMUM WIDTH / HEIGHT

1200 MM / 3000 MM

WEIGHT LIMIT PER FRAME

120 KG

PROFILE FRAME FINISH / ANODISED

BLACK MATT / BRUSH GOLD /
CHAMPANGE / ROSE GOLD / DARK GREY

ALUMINIUM PROFILE SUITABLE FOR

8 MM / 10 MM GLASS

AVAILABLE WITH LOCK OPTION

HARDWARE

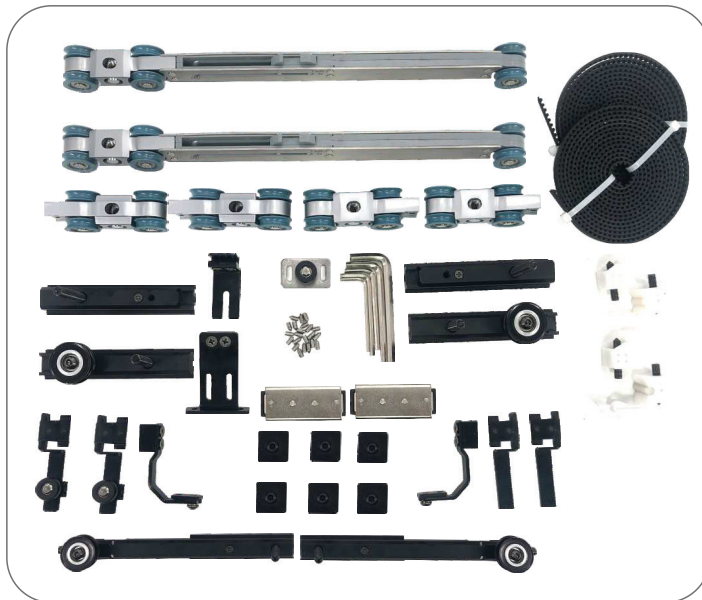

BWAY Telescopic Sliding Set - 1 Fix 3 Sliding Door
BWAY-TSL-1+3

BWAY Telescopic Sliding Set - 1 Fix 4 Sliding Door
BWAY-TSL-1+4

PROFILES & ACCESSORIES

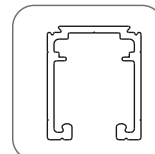

Sliding Top Track
BWAY-T1

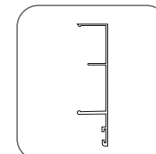

Track Cover
BWAY-TC-T1



Fixed Glass Clamp
BWAY-FGC-DF-T1

4516-Series

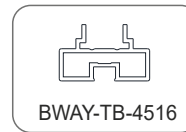

BWAY-TB-4516

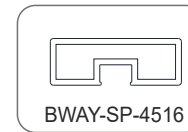

BWAY-SP-4516

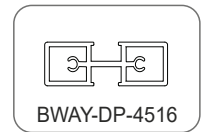

BWAY-DP-4516

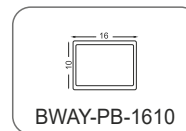

BWAY-PB-1610

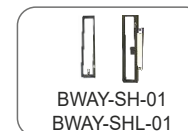

BWAY-SH-01
BWAY-SHL-01



BWAY-LJ-90-4516
BWAY-GASKET
4516-Plastic

4507-Series

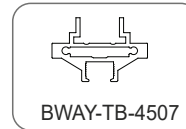

BWAY-TB-4507

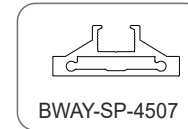

BWAY-SP-4507

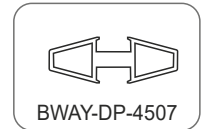

BWAY-DP-4507

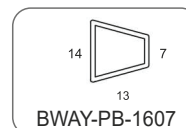

BWAY-PB-1607



BWAY-SH-02
BWAY-SHL-02



BWAY-LJ-90-4507
BWAY-GASKET
4507-Plastic

TELESCOPIC SOFT CLOSE SLIDING
1 FIX + 3 SLIDING DOOR



SYNCHRO SOFT CLOSE SLIDING 2 FIX + 2 SLIDING DOOR

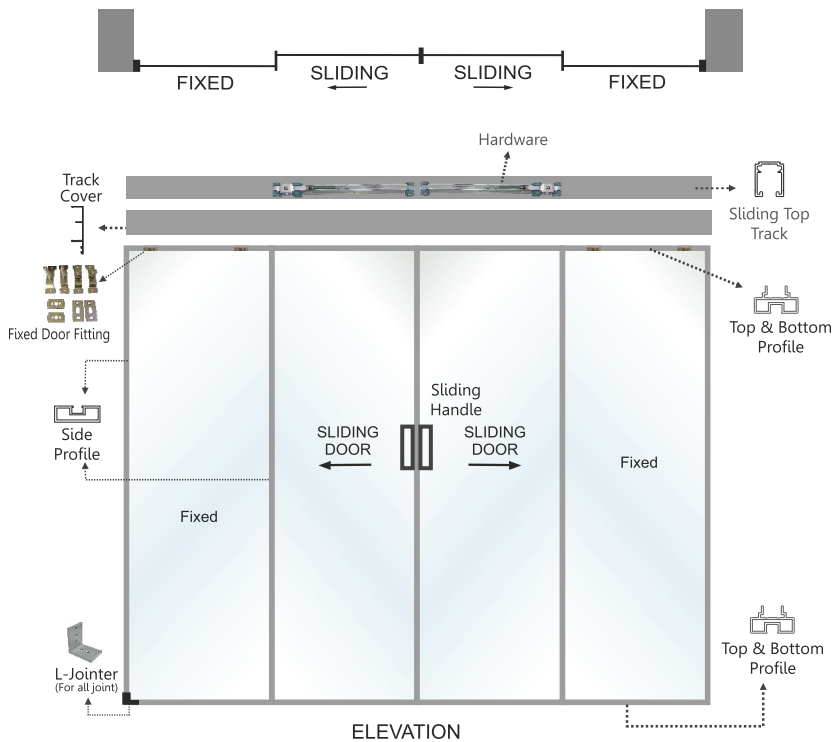

CONFIGURATION
2 FIX + 2 SLIDING DOOR

MAXIMUM WIDTH / HEIGHT
1200 MM / 3000 MM

WEIGHT LIMIT PER FRAME
120 KG

PROFILE FRAME FINISH / ANODISED
BLACK MATT / BRUSH GOLD /
CHAMPANGE / ROSE GOLD / DARK GREY

ALUMINIUM PROFILE SUITABLE FOR
8 MM / 10 MM GLASS

AVAILABLE WITH LOCK OPTION

HARDWARE



BWAY Synchro Sliding Set - 2 Fix 2 Sliding Door
BWAY-SYN-2+2

PROFILES & ACCESSORIES

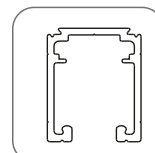

Sliding Top Track
BWAY-T1

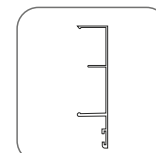

Track Cover
BWAY-TC-T1



Fixed Glass Clamp
BWAY-FGC-DF-01

4516-Series

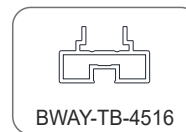

BWAY-TB-4516

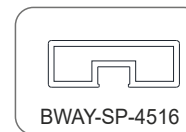

BWAY-SP-4516

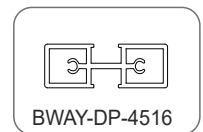

BWAY-DP-4516

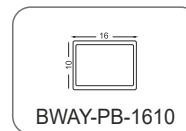

BWAY-PB-1610



BWAY-SH-01
BWAY-SHL-01



BWAY-LJ-90-4516
BWAY-GASKET 4516-Plastic

4507-Series

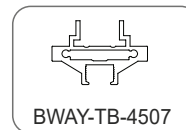

BWAY-TB-4507

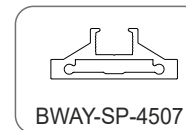

BWAY-SP-4507

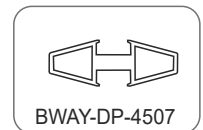

BWAY-DP-4507

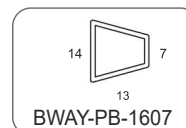

BWAY-PB-1607



BWAY-SH-02
BWAY-SHL-02



BWAY-LJ-90-4507
BWAY-GASKET 4507-Plastic

SYNCHRO SOFT CLOSE SLIDING
2 FIX + 2 SLIDING DOOR

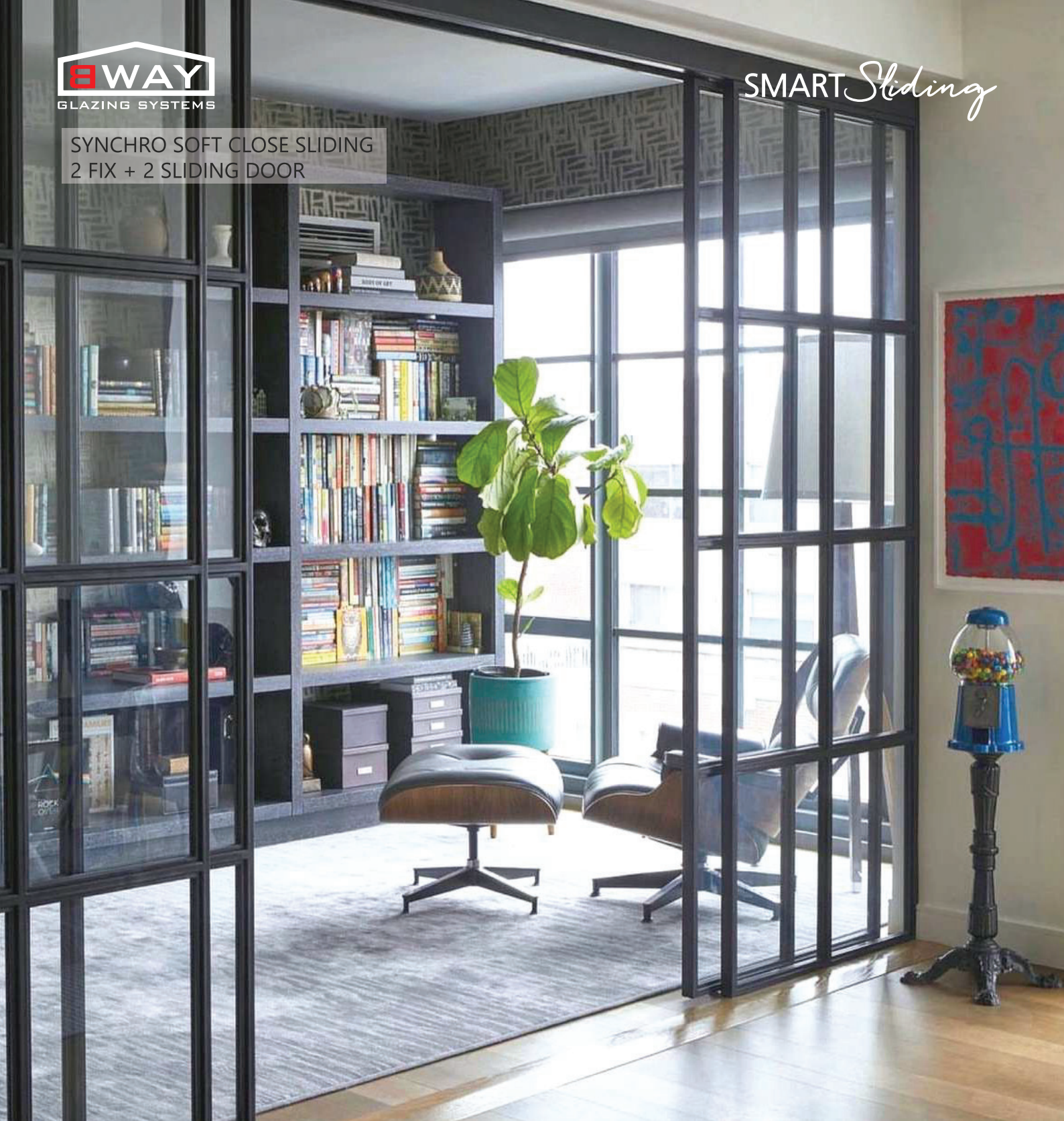

QUALITY is the best
business plan

John Lasseter

TELESCOPIC+SYNCHRO SOFT CLOSE SLIDING



BWAY Telescopic + Synchro Sliding Set - 2FIX+4 Sliding Door Hardware

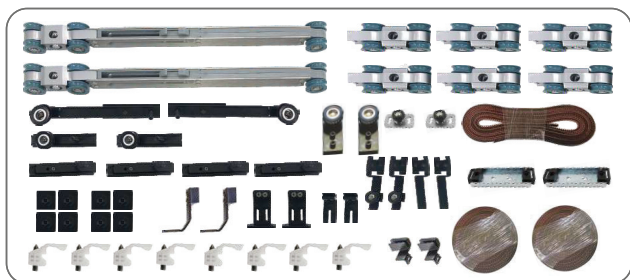

BWAY-TLS+SYN 2+4 (2 Fix + 4 Door Sliding)



BWAY-FGC-DF-01

(Maximum Door weight per panel should not exceed 50kg)

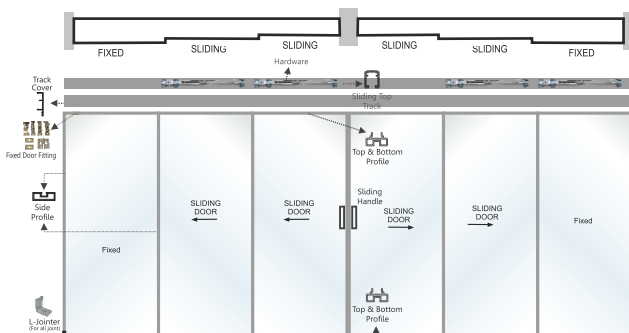

BWAY-Telescopic + Synchro Sliding Set - 2 FIX+6 Sliding Door Hardware

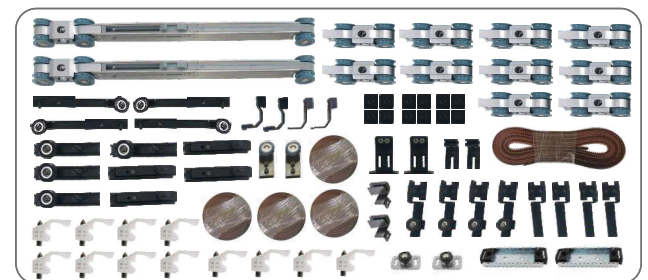

BWAY-TLS+SYN 2+6 (2 Fix + 6 Door Sliding)



BWAY-FGC-DF-01

(Maximum Door weight per panel should not exceed 50kg)

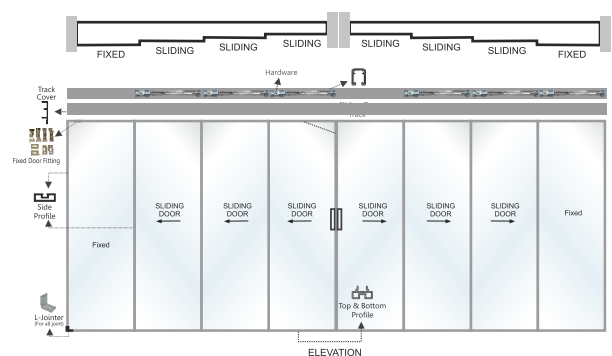



SMART Sliding

ONE WAY SOFT CLOSE DOUBLE SLIDING DOOR

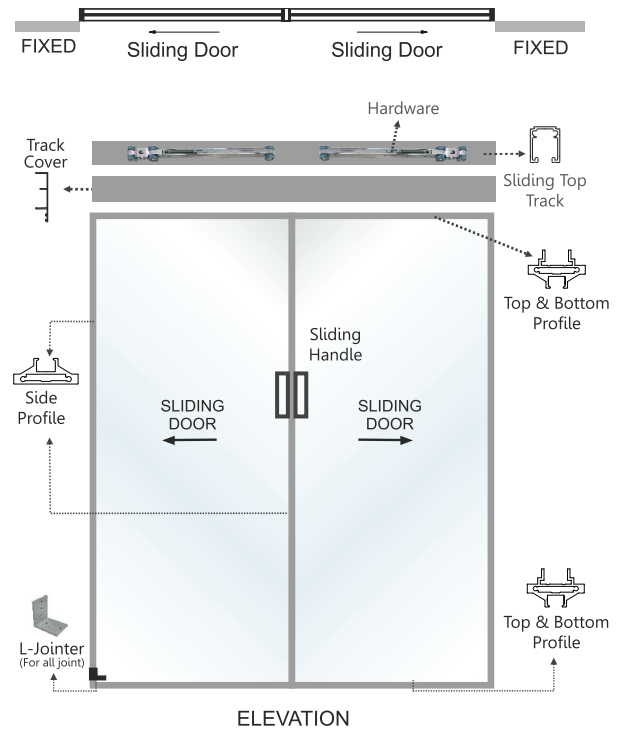







HARDWARE

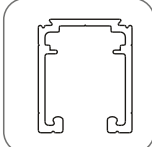
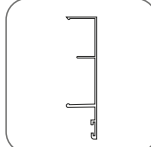

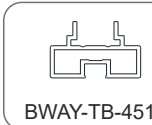
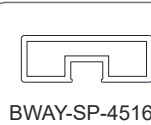
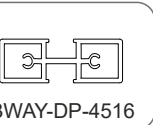
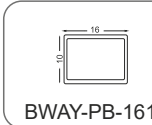
BWAY One Way Soft Close Sliding for Double Door
BWAY-SCS-2102

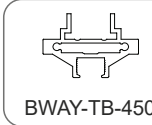
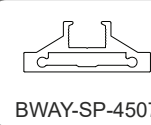
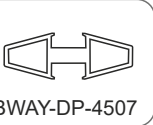
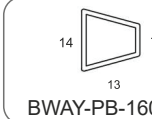
PROFILES & ACCESSORIES

		
Sliding Top Track BWAY-T1	Track Cover BWAY-TC-T1	Fixed Glass Clamp BWAY-FGC-DF-01
4516-Series		
		
BWAY-TB-4516	BWAY-SP-4516	BWAY-DP-4516
		
BWAY-PB-1610	BWAY-SH-01 BWAY-SHL-01	BWAY-LJ-90-4516 BWAY-GASKET 4516-Plastic
4507-Series		
		
BWAY-TB-4507	BWAY-SP-4507	BWAY-DP-4507
		
BWAY-PB-1607	BWAY-SH-02 BWAY-SHL-02	BWAY-LJ-90-4507 BWAY-GASKET 4507-Plastic

SMART Sliding

ONE WAY SOFT CLOSE SINGLE SLIDING DOOR

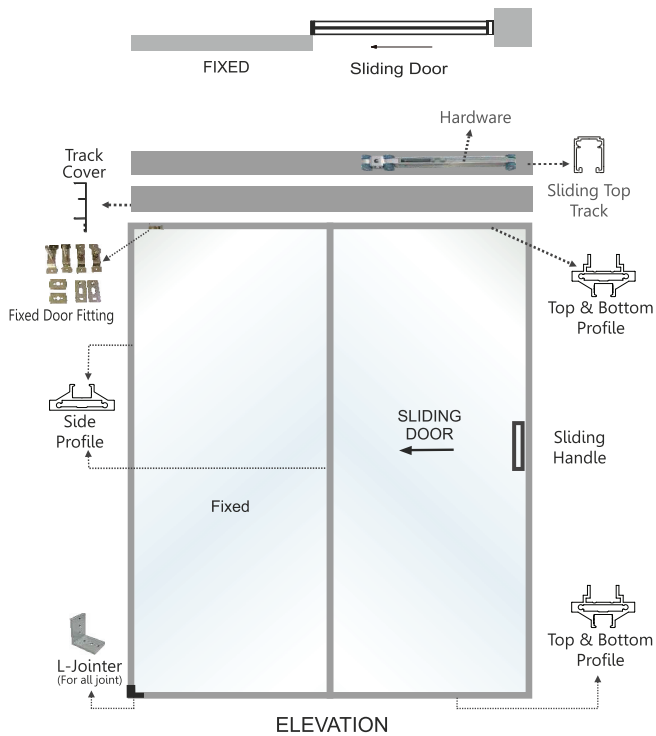

HARDWARE



BWAY One Way Sliding for Single Door
BWAY-SCS-2101

PROFILES & ACCESSORIES

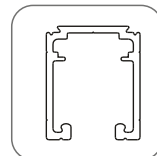

Sliding Top Track
BWAY-T1

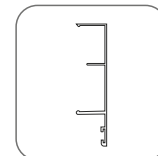

Track Cover
BWAY-TC-T1



Fixed Glass Clamp
BWAY-FGC-DF-01

4516-Series

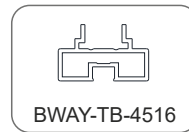

BWAY-TB-4516

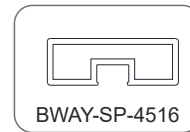

BWAY-SP-4516

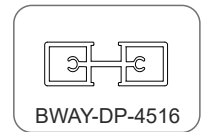

BWAY-DP-4516

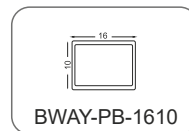

BWAY-PB-1610



BWAY-SH-01
BWAY-SHL-01



BWAY-LJ-90-4516
BWAY-GASKET
4516-Plastic

4507-Series

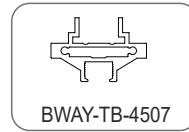

BWAY-TB-4507

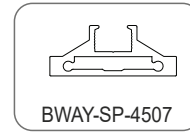

BWAY-SP-4507

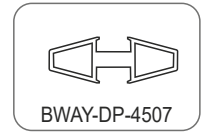

BWAY-DP-4507

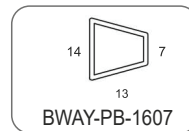

BWAY-PB-1607



BWAY-SH-02
BWAY-SHL-02



BWAY-LJ-90-4507
BWAY-GASKET
4507-Plastic

SMART Sliding

TWO WAY SOFT CLOSE SINGLE SLIDING DOOR

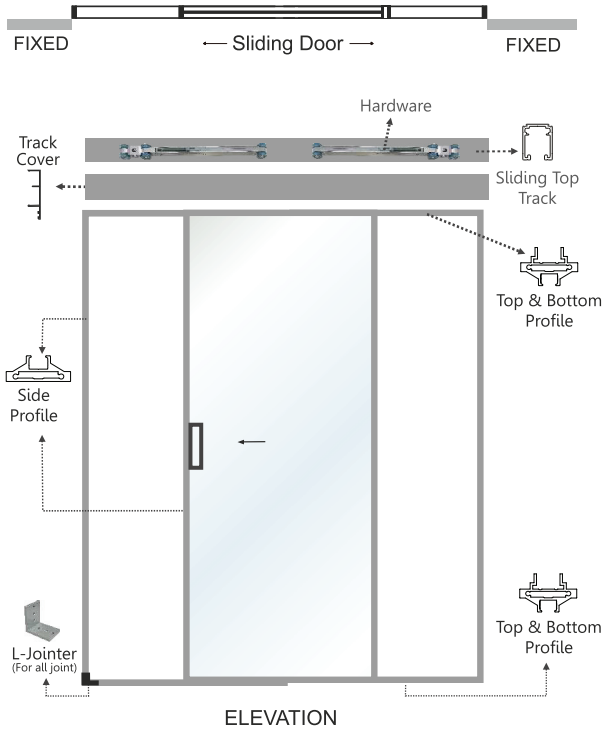

HARDWARE



BWAY Two Way Soft close single sliding door
(Note : Size exceed more than 900mm)

BWAY-TWSC-2104

HARDWARE



BWAY Two Way Soft close single sliding door
(Note : Size should not exceed more than 900mm)

BWAY-SC-2105

PROFILES & ACCESSORIES

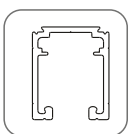

Sliding Top Track
BWAY-T1

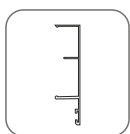

Track Cover



Fixed Glass Clamp
BWAY-FGC-DF-01

4516-Series

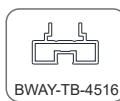

BWAY-TB-4516

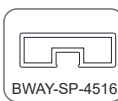

BWAY-SP-4516

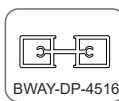

BWAY-DP-4516

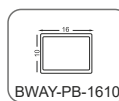

BWAY-PB-1610



BWAY-SH-01
BWAY-SHL-01



BWAY-LJ-90-4516



BWAY-GASKET
4516-Plastic

4507-Series

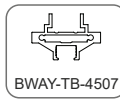

BWAY-TB-4507

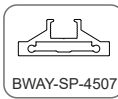

BWAY-SP-4507

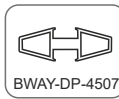

BWAY-DP-4507



BWAY-PB-1607



BWAY-SH-02
BWAY-SHL-02



BWAY-LJ-90-4507



BWAY-GASKET
4517-Plastic

INVISIBLE SLIDING - 2106 SINGLE DOOR
WITH SOFT CLOSE



HARDWARE



BWAY Invisible Sliding with Soft Close
Max. Size : 2600mm x 1200mm Framed Single Door

PROFILES & ACCESSORIES

Max. Size :
Side Profile : 2600mm
Top Bottom : 1200mm

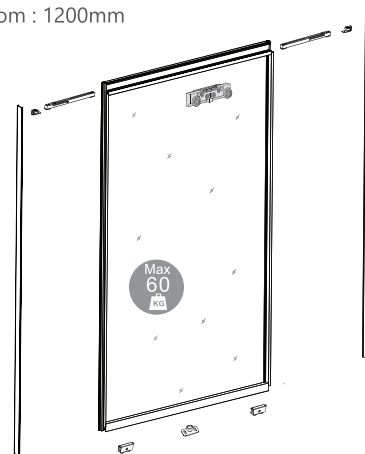

INVISIBLE SLIDING - 2108 SINGLE DOOR WITH SOFT CLOSE



HARDWARE

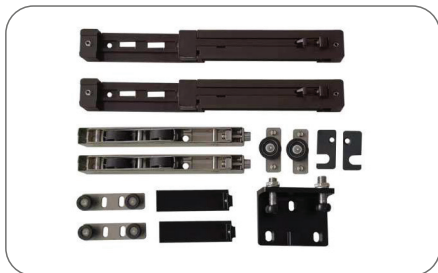

New

BWAY Invisible Sliding with Soft Close used with BWAY-SP-4516
Max. Size : 3000mm x 1200mm

BWAY-SC-2108

Finish : Black Matte & Brush Gold

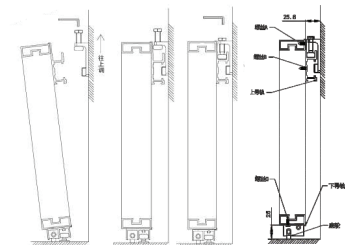

PROFILES & ACCESSORIES

4516-Series





SMART Sliding

POCKET SLIDING - 2107
SINGLE DOOR
WITH SOFT BOUNCE CLOSE

HARDWARE



BMWAY Pocket Sliding Single Door with Soft Bounce Close
Max. Size : 2600mm x 1200mm Framed Single Door
BWAY-SC-2107

PROFILES & ACCESSORIES

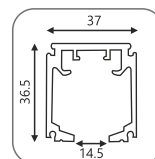

Sliding Top Track (New)
BWAY-T1-1288
BM-4mtr

4516-Series

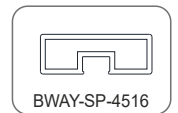
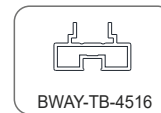

4507-Series

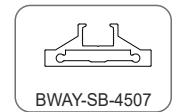
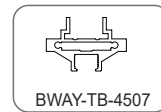

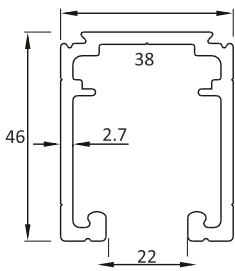

Top Track
BWAY-T1

- 3600 MM
- Black Matte
- Brush Gold
- Brush Champagne
- Dark Grey
- Rose Gold
- Bronze
- 4800 MM
- 6000 MM

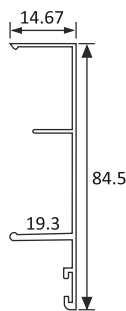

Track Cover : Code
BWAY-TC-T1

- 3600 MM
- Black Matte
- Brush Gold
- Brush Champagne
- Dark Grey
- Rose Gold
- Bronze
- 4800 MM
- 6000 MM

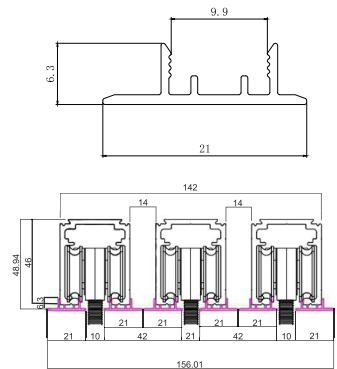

Track Concealer with
Clip on : BWAY-1411 (Optional)

- 4800 MM
- Black Matte
- Brush Gold
- Brush Champagne
- Dark Grey
- Rose Gold
- Bronze
- 6000 MM

45mm x 16mm Profile

Top & Bottom Profile : Code : BWAY-TB-4516

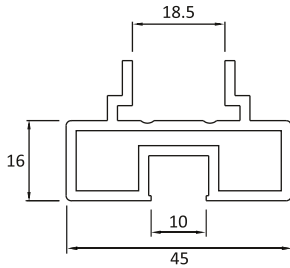

- 3000 MM
 - Black Matte
 - Brush Gold
 - Brush Champagne
 - Dark Grey
 - Rose Gold
 - Bronze
- 3600 MM
 - 4800 MM
 - 6000 MM

Side Profile : Code : BWAY-SP-4516

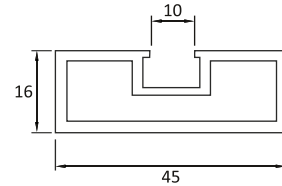

- 3000 MM
 - Black Matte
 - Brush Gold
 - Brush Champagne
 - Dark Grey
 - Rose Gold
 - Bronze
- 3600 MM
 - 4800 MM
 - 6000 MM

Divider Profile : Code : BWAY-DP-4516

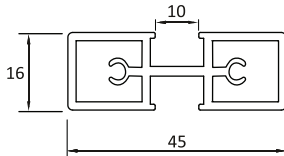

- 3000 MM
 - Black Matte
 - Brush Gold
 - Brush Champagne
 - Dark Grey
 - Rose Gold
 - Bronze
- 3600 MM
 - 4800 MM
 - 6000 MM

Divider Profile : Code : BWAY-DP-4517

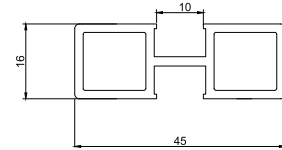

- 3600 MM
 - Black Matte
 - Brush Gold
 - Brush Champagne
 - Dark Grey
 - Rose Gold
 - Bronze
- 4800 MM
 - 6000 MM

**Partition Bar : Code : BWAY-PB-1610
(Georgian Bar)**

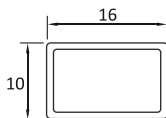

- 3000 MM
 - Black Matte
 - Brush Gold
 - Brush Champagne
 - Dark Grey
 - Rose Gold
 - Bronze
- 3600 MM
 - 4800 MM
 - 6000 MM

**Partition Bar : Code : BWAY-PB-1618
(Georgian Bar)**

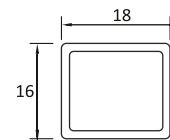

- 3600 MM
 - Black Matte
 - Brush Gold
 - Brush Champagne
 - Dark Grey
 - Rose Gold
 - Bronze
- 4800 MM
 - 6000 MM



BWAY-LJ-90-4516



BWAY-LJ-90-4516



BWAY-GASKET 4516-Platic

BWAY-IMP-4535

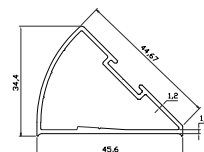

- 3600 MM
 - Black Matte
 - Brush Gold
 - Brush Champagne
 - Dark Grey
 - Rose Gold
 - Bronze
- 4800 MM
 - 6000 MM



Sliding Handle

4516 Profile



Black Matt
BWAY-SH-01-BM
(4516)



Brush Gold
BWAY-SH-01-BG
(4516)



Champagne
BWAY-SH-01-CH
(4516)



Rose Gold
BWAY-SH-01-RG
(4516)



Dark Grey
BWAY-SH-01-DG
(4516)



Bronze
BWAY-SH-01-BR
(4516)

Sliding Handle with Lock

4516 Profile



Black Matt
BWAY-SHL-01-BM
(4516)



Brush Gold
BWAY-SHL-01-BG
(4516)



Champagne
BWAY-SHL-01-CH
(4516)



Rose Gold
BWAY-SHL-01-RG
(4516)



Dark Grey
BWAY-SHL-01-DG
(4516)



Bronze
BWAY-SHL-01-BR
(4516)

Sliding Handle

4507 Profile



Black Matt
BWAY-SH-01-BM
(4507)



Brush Gold
BWAY-SH-02-BG
(4507)



Champagne
BWAY-SH-02-CH
(4507)



Rose Gold
BWAY-SH-02-RG
(4507)



Dark Grey
BWAY-SH-02-DG
(4507)



Bronze
BWAY-SH-02-BR
(4507)

Sliding Handle with Lock

4507 Profile



Black Matt
BWAY-SHL-02-BM
(4507)



Brush Gold
BWAY-SHL-02-BG
(4507)



Champagne
BWAY-SHL-02-CH
(4507)



Rose Gold
BWAY-SHL-02-RG
(4507)



Dark Grey
BWAY-SHL-02-DG
(4507)



Bronze
BWAY-SHL-02-BR
(4507)

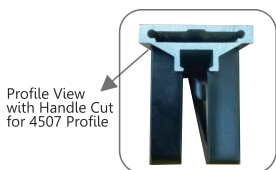

Sliding Handle

3516 & 4010 Profile



Black Matt BWAY-SH-03-BM (3516/4010)	Brush Gold BWAY-SH-03-BG (3516/4010)	Champagne BWAY-SH-03-CH (3516/4010)	Rose Gold BWAY-SH-03-RG (3516/4010)	Dark Grey BWAY-SH-03-DG (3516/4010)	Bronze BWAY-SH-03-BR (3516/4010)
---	---	--	--	--	---



Sliding Handle with Lock

3516 & 4010 Profile



Black Matt BWAY-SHL-03-BM (3516/4010)	Brush Gold BWAY-SHL-03-BG (3516/4010)	Champagne BWAY-SHL-03-CH (3516/4010)	Rose Gold BWAY-SHL-03-RG (3516/4010)	Dark Grey BWAY-SHL-03-DG (3516/4010)	Bronze BWAY-SHL-03-BR (3516/4010)
--	--	---	---	---	--

Stick on Sliding Z-Handle

New



Black Matt
BWAY-SH-04-BM



Brush Gold
BWAY-SH-04-BG



Champagne
BWAY-SH-04-CH



Rose Gold
BWAY-SH-04-RG



Dark Grey
BWAY-SH-04-DG



Bronze
BWAY-SH-04-BR

Stick on Sliding Round Handle New



Black Matt
BWAY-SH-04-BM



Brush Gold
BWAY-SH-04-BG



Champagne
BWAY-SH-05-CH



Rose Gold
BWAY-SH-05-RG



Dark Grey
BWAY-SH-05-DG



Bronze
BWAY-SH-05-BR

Sliding Door Locks BWAY-LOCK-02



Black Matte
BWAY-LOCK-02-4516-BM
BWAY-LOCK-02-4507-BM



Brush Gold
BWAY-LOCK-02-4516-BG
BWAY-LOCK-02-4507-BG



Brush Champagne
BWAY-LOCK-02-4516-CH
BWAY-LOCK-02-4507-CH



Dark Grey
BWAY-LOCK-02-4516-DG
BWAY-LOCK-02-4507-DG



Rose Gold
BWAY-LOCK-02-4516-RG
BWAY-LOCK-02-4507-RG



Bronze
BWAY-LOCK-02-4516-BR
BWAY-LOCK-02-4507-BR

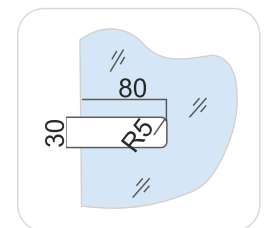

One side Lock/ One side Knob use for Sliding and Openable Door

Hardware



BWAY-MW-3-Slide Door
Max Door Width : 900 mm

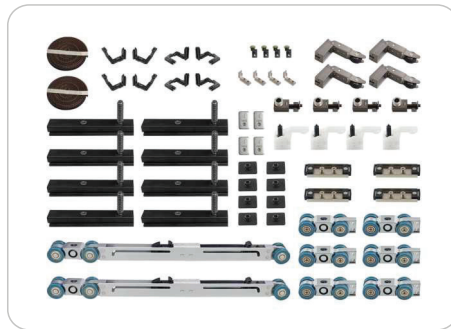

BWAY-MW-4-Slide Door
Max Door Width : 900 mm

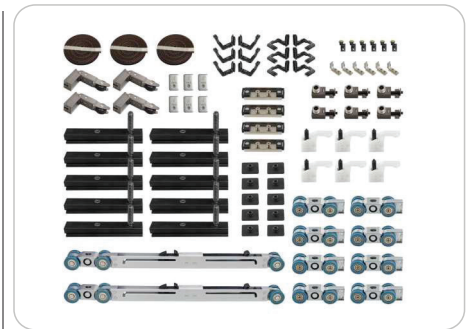

BWAY-MW-5-Slide Door
Max Door Width : 900 mm

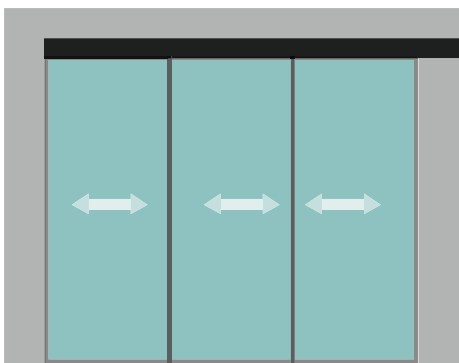
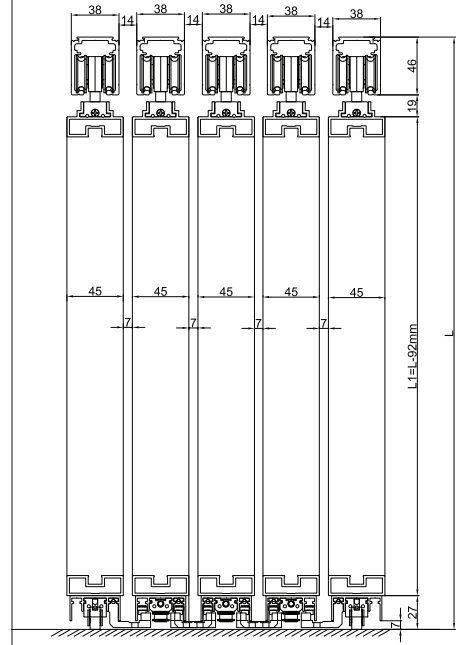
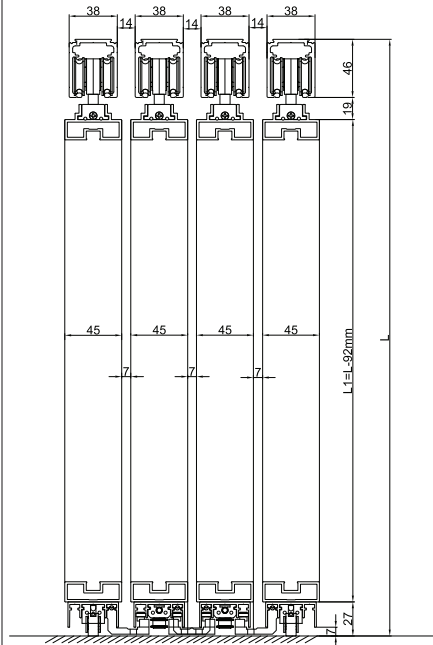
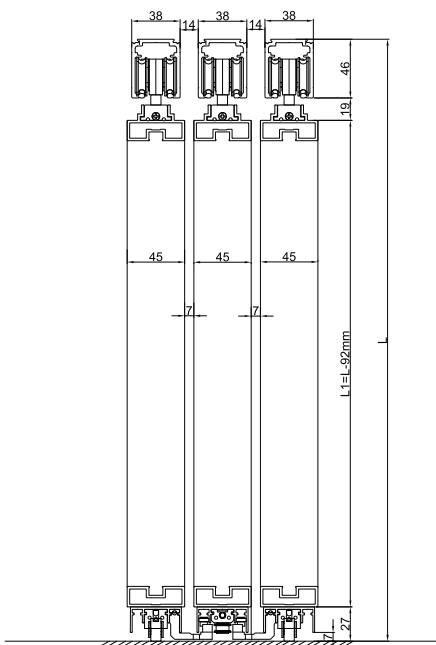

3 SLIDING DOOR

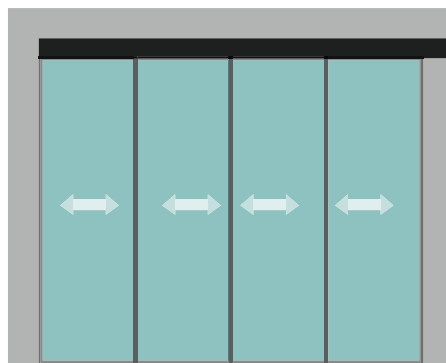

4 SLIDING DOOR

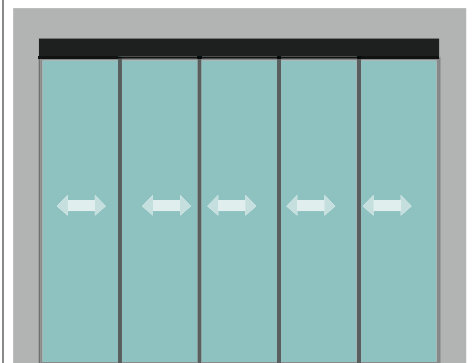

5 SLIDING DOOR

SMART *Sliding*



ELECTROMAGNETIC DRIVER INTELIGENT



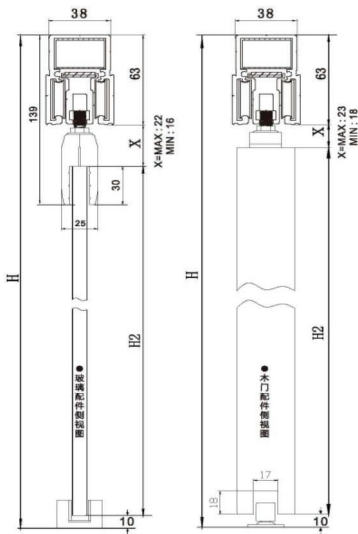

Noise	< 40dB
Standby Power Consumption	< 5W
Operational Power Consumption	<100W
Resostance - Rebound	<10N
Voltage (dc)	220V / 110V

Features

- Suitable for single or multiple sliding doors
- Suitable for sliding doors for families, hotels, office building etc.
- Multiple open mode, quieter and safer

Material and finishes

- Sliding track : Aluminum and spray sand black
- Hanging roller : Aluminum and spray Sand black
- Bracket : Iron
- Glass Clap : Alumium and spray sand black

Multiple Opening Modes Available :



**Sensor
BWAY-125-18**



**Sensor
BWAY-MT-SS-2**



**Button switch
BWAY-MT-BS**



**Electronic Lock
BWAY-MT-E Lock**

Extra Profile & Accessories

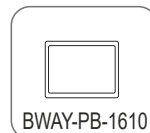
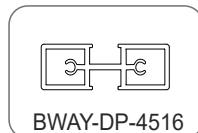
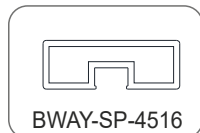
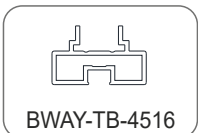

ELECTROMAGNETIC DRIVER INTELIGENT
TELESCOPIC AND SYNCHRO SOFT CLOSE SLIDING - AUTO CLOSE / OPEN

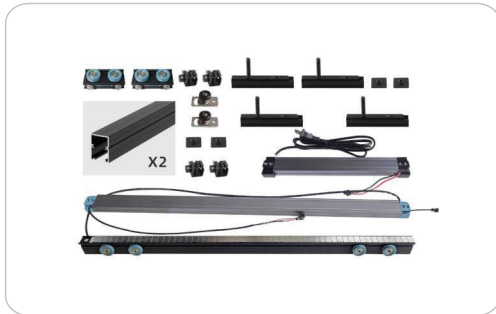

BWAY-MT07-1 Fix+1 Slide
Max Door Width : 1200 mm

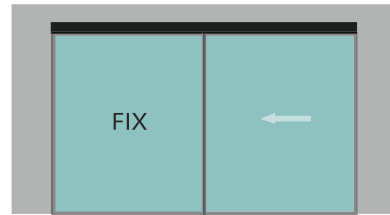

1 FIX + 1 SLIDING DOOR

Track Length : 2375 x 2 PC
Track Cover : 2375 x 2 PC
End Cap : 2 PC
Finish : Black/Brush Gold
Suitable with : 4516-Series

MAGTOUCH SLIDING SYSTEMS
COMES WITH WIRELESS
PUSH BUTTON, 2 REMOTE
AND 1 INBUILT E-LOCK



BWAY-MT08-1 Fix+2 Slide
Max Door Width : 1200 mm

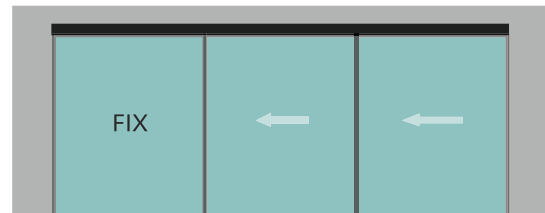

1 FIX + 2 SLIDING DOOR

Track Length : 3550 x 3 PC
Track Cover : 3550 x 2 PC
End Cap : 2 PC
Finish : Black/Brush Gold
Suitable with : 4516-Series

MAGTOUCH SLIDING SYSTEMS
COMES WITH WIRELESS
PUSH BUTTON, 2 REMOTE
AND 1 INBUILT E-LOCK

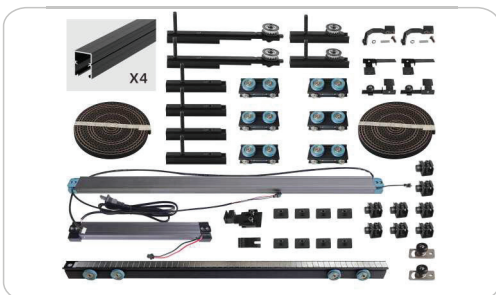

BWAY-MT09-1 Fix+3 Slide
Max Door Width : 1200 mm

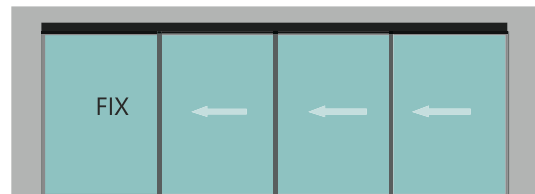

1 FIX + 3 SLIDING DOOR

Track Length : 4750 x 4 PC
Track Cover : 4750 x 2 PC
End Cap : 2 PC
Finish : Black/Brush Gold
Suitable with : 4516-Series

MAGTOUCH SLIDING SYSTEMS
COMES WITH WIRELESS
PUSH BUTTON, 2 REMOTE
AND 1 INBUILT E-LOCK



BWAY-MT10-2 Fix+2 Slide
Max Door Width : 1200 mm

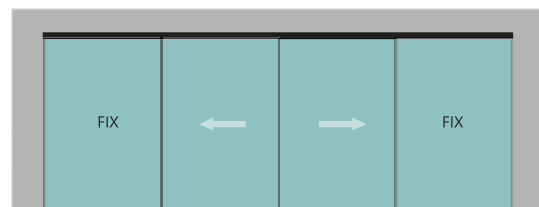

2 FIX + 2 SLIDING DOOR

Track Length : 2375 x 4 PC
Track Cover : 2375 x 4 PC
End Cap : 2 PC
Finish : Black / Brush Gold
Suitable with : 4516-Series

MAGTOUCH SLIDING SYSTEMS
COMES WITH WIRELESS
PUSH BUTTON, 2 REMOTE
AND 1 INBUILT E-LOCK

Available in Black Matte & Brush Gold
suitable with 4516 series profile



OUTER FRAMED DOOR PARTITION
 MINIMAL-45 SERIES IN 6 COLOUR (NEW) - ANODISE

New

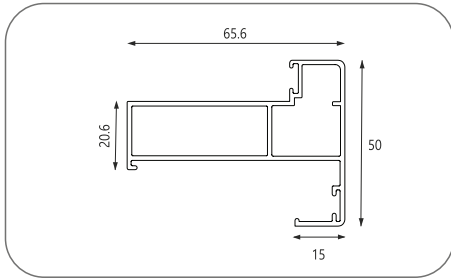

Outer Frame Profile
BWAY-OFP-1350

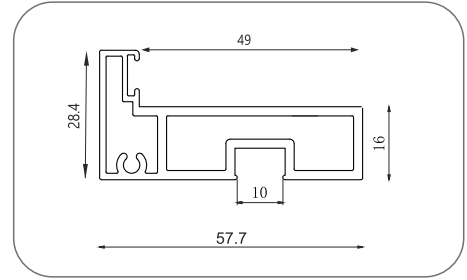

Slim Outer Frame Profile
BWAY-OFP-1351

- 3600 MM
- Black Matte
- Brush Gold
- Brush Champagne
- Dark Grey
- Rose Gold
- Bronze
- 4800 MM
- 6000 MM

- 3600 MM
- Black Matte
- Brush Gold
- Brush Champagne
- Dark Grey
- Rose Gold
- Bronze
- 4800 MM
- 6000 MM

4516-Series

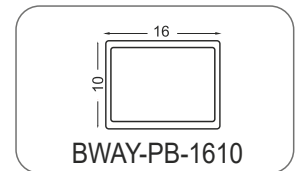
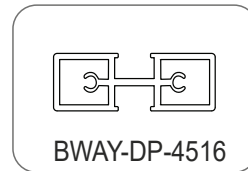
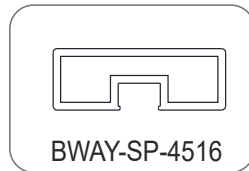
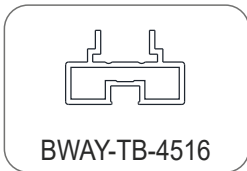

4507-Series

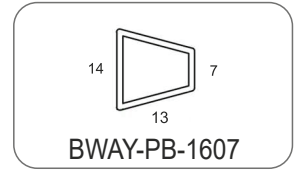
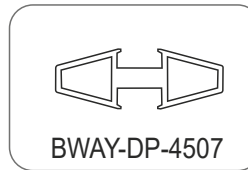
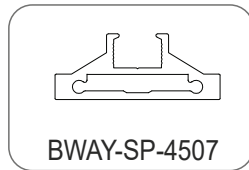
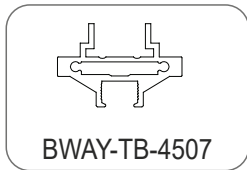

Outer Frame Profile Connector and Gasket

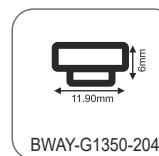

OUTER FRAMED DOOR PARTITION
WITH 45 SERIES IN 6 COLOUR (NEW)



SMART Partition

CONFIGURATION

SWING DOOR WITH PIVOT/HINGE

MAXIMUM WIDTH / HEIGHT

1500 MM / 3600 MM

WEIGHT LIMIT

90 KG

PROFILE FRAME FINISH / ANODISED

BLACK MATT / BRUSH GOLD /
CHAMPAGNE / ROSE GOLD/ DARK
GREY

ALUMINIUM PROFILE SUITABLE FOR

8 MM / 10 MM GLASS

AVAILABLE WITH LOCK OPTION

TOP BOTTOM PIVOT

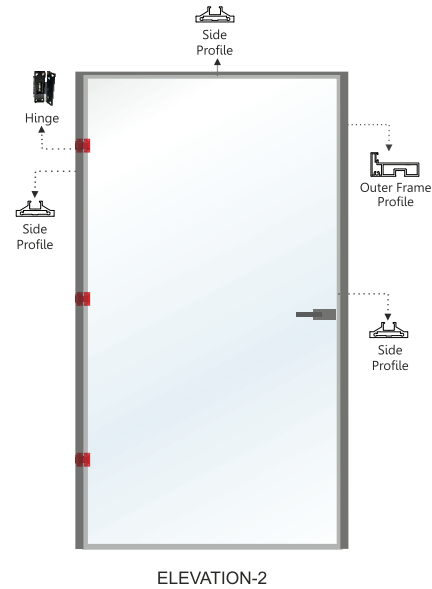
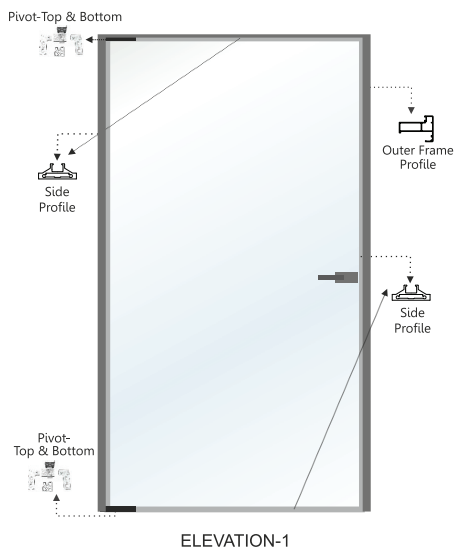

HARDWARE & ACCESSORIES



BWAY-PIVOT-3005
(Capacity 70 kg)



Concealed Hinge
BWAY-Hinge-505(4516)

Black Gold Champagne Dark Grey Rose Gold Bronze



SHOWER DOOR PIVOT
BWAY-PIVOT-3006

Black Gold Champagne Dark Grey Rose Gold Bronze



BUTTERFLY
BWAY-507



BWAY-LJ-90-1351



BWAY-LJ-90-1350

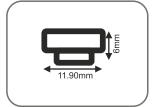

Gasket -
BWAY-204-G1350/1351





LUXE-45®

FRAMED DOOR PARTITION WITH FLOOR SPRING, PNEUMATIC & AUTOMATIC

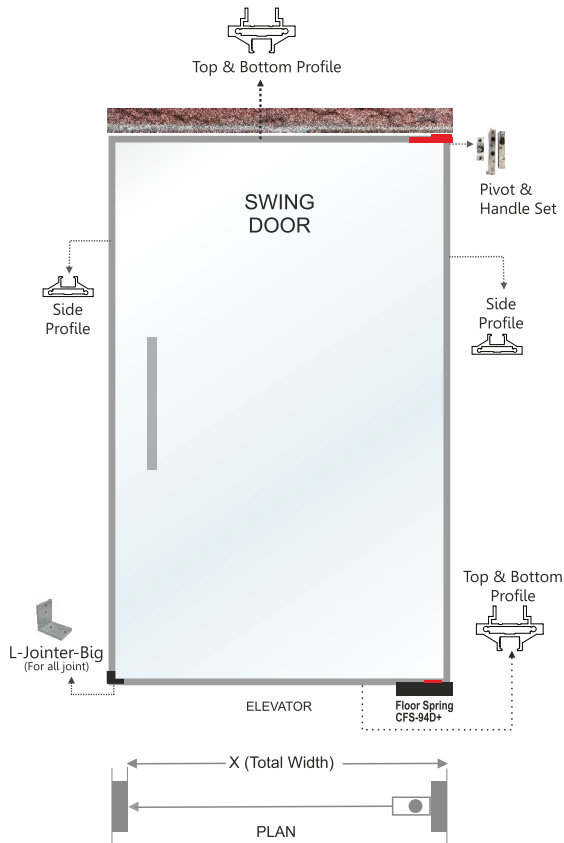

CONFIGURATION
SWING DOOR PIVOT

MAXIMUM WIDTH / HEIGHT
1200 MM / 3000 MM

WEIGHT LIMIT
120 KG

PROFILE FRAME FINISH / ANODISED
BLACK MATT / BRUSH GOLD /
CHAMPANGE / ROSE GOLD / DARK GREY

ALUMINIUM PROFILE SUITABLE FOR
8 MM / 10 MM GLASS

AVAILABLE WITH LOCK OPTION

Frame Door Closing Devices



BWAY-84D+

- Black Matte
- Brush Gold
- Brush Champagne
- Dark Grey
- Rose Gold
- Bronze



BWAY-80D+

- Black Matte
- Brush Gold
- Brush Champagne
- Dark Grey
- Rose Gold
- Bronze



BWAY-PIVOT-3003

4516-Series

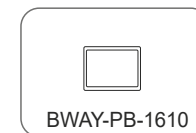
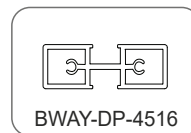
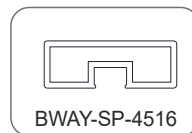
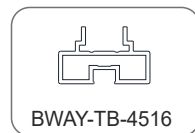

4507-Series

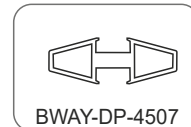
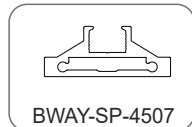
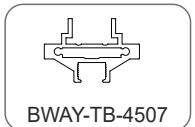

360° DOOR



SMART Partition

Pneumatic Floor Hinge

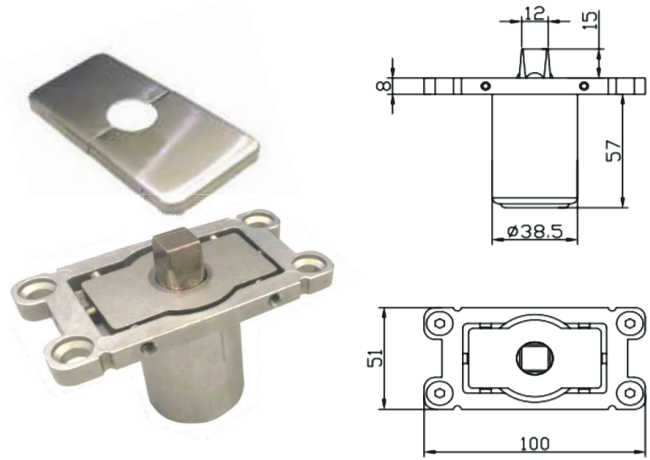

BWAY-888 - Pneumatic Floor Hinge 70kg/140kg/200kg

AUTOMATIC SWING DOOR OPERATOR



BWAY-OW-150

Features

- The automatic door of this model are the 3rd generation single-opened one-way buried doors developed by our company.
- They are characterized by small volume, low noise at running, easy installation, and stable performance etc.
- The door is to be driven by the brush less DC motor, which has a long service life and responds rapidly. This is fully embodied in the anti-trap function of the door.

Functional Characteristic	CASD-OW-150			
	Indoor	Outdoor	Indoor	Outdoor
Waterproof effect width	IPX7	IPX8	IPX7	IPX8
Open direction	Unidirectional opening		Bidirectional opening	
Applicable to	Vertical hinged door of all materials			
Door width	Less than 1,200mm			
Door weight	150 KG			

MINI FLOOR HINGE

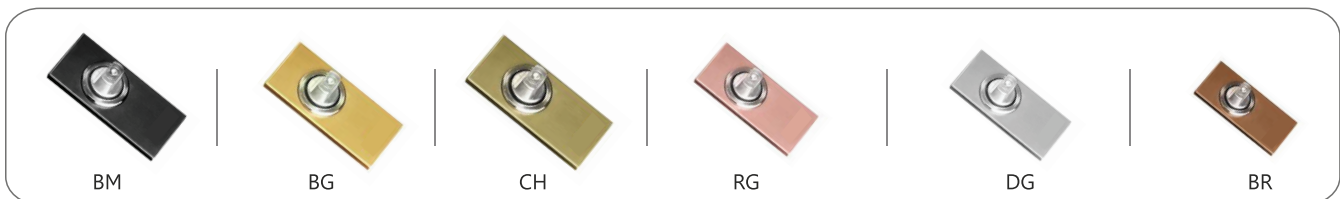

BWAY-110-12C

Accessories (Framed)



Black Matte
BWAY-LOCK-01-4516-BM

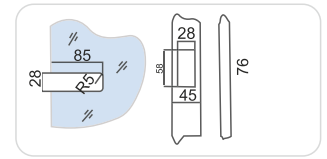
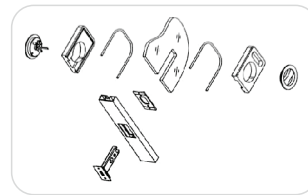

Sliding Handle with Lock/Knob

Openable Door Locks BWAY-LOCK-02

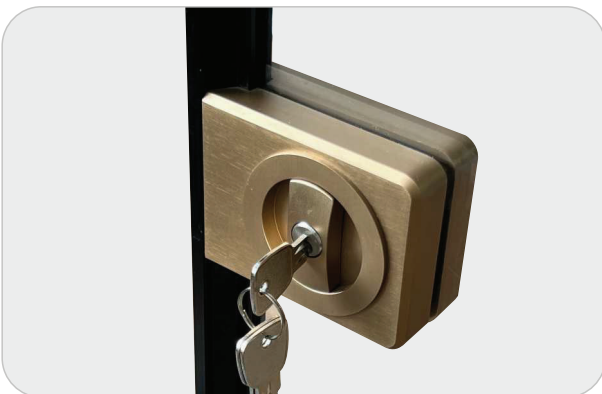

One side Lock/ One side Knob use for Sliding and Openable Door



Black Matte
BWAY-LOCK-02-4516-BM
BWAY-LOCK-02-4507-BM



Brush Gold
BWAY-LOCK-02-4516-BG
BWAY-LOCK-02-4507-BG



Brush Champagne
BWAY-LOCK-02-4516-CH
BWAY-LOCK-02-4507-CH



Dark Grey
BWAY-LOCK-02-4516-DG
BWAY-LOCK-02-4507-DG



Rose Gold
BWAY-LOCK-02-4516-RG
BWAY-LOCK-02-4507-RG



Bronze
BWAY-LOCK-02-4516-BR
BWAY-LOCK-02-4507-BR

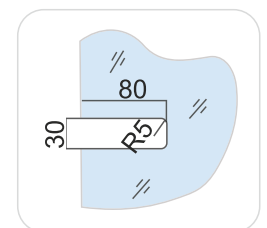

Mortice Handle with Lock Suitable for Profile **BWAY-SP-4507**

CODE : BWAY-MHL-05



Black Matt



Brush Gold



Champagne



Rose Gold



DarkGrey



Bronze

Mortice Handle with Lock Suitable for Profile **BWAY-SP-4010** **NEW** Premium Series

CODE : BWAY-MHL-11



Black Matt



Brush Gold



Champagne



Rose Gold



DarkGrey



Bronze

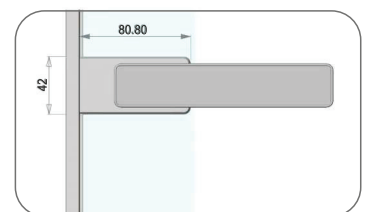



SHOWER DOOR PIVOT

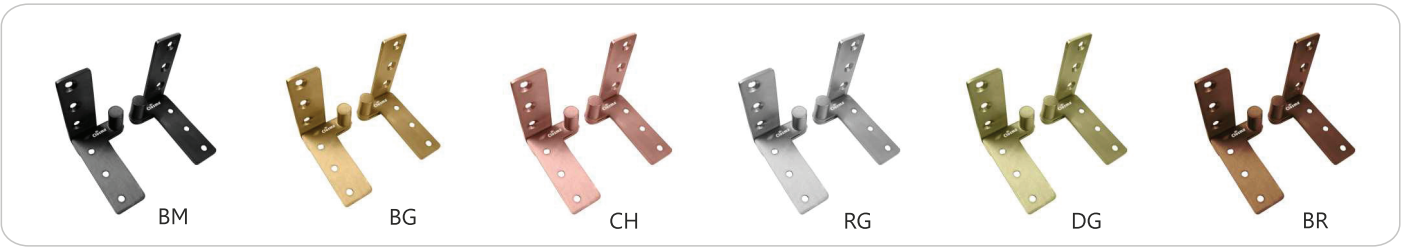

BWAY-PIVOT-3006
(Capacity 70-90 kg)

- Finish
- Black Matte
- Brush Gold
- Brush Champagne
- Dark Grey
- Rose Gold
- Bronze

CONCEALED HINGE

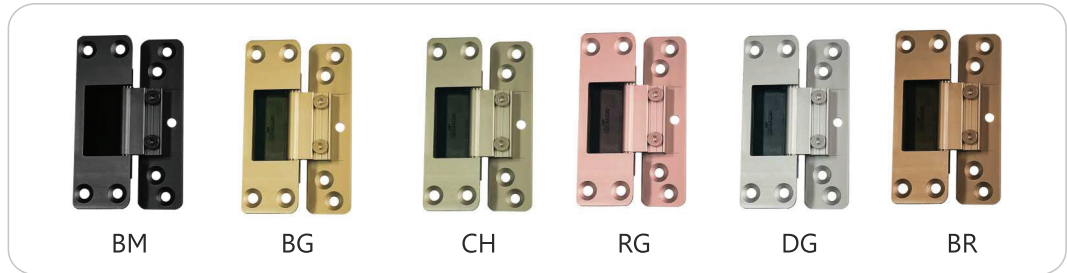

BWAY-Hinge-508 (3516)
(Capacity 40 kg)

- Finish
- Black Matte
- Brush Gold
- Brush Champagne
- Dark Grey
- Rose Gold
- Bronze

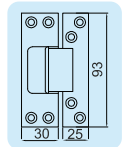

3516

NEW DOOR MAGNET



BWAY-SHP-M2
Shower Door
Magnetic Seal Set
for Frame Door



BWAY-SHP-M3
Shower Door
Magnetic Seal Set
for Frame Door



BWAY-LJ-90-4040

SMART Shower®

FRAMED SHOWER PARTITION
WITH FRAMELESS DOOR

8WAY
GLAZING SYSTEMS



FRAMELESS SOFT CLOSE SLIDING DOOR
Specialized Frame Less Sliding



One Way Soft Close Sliding Hardwares

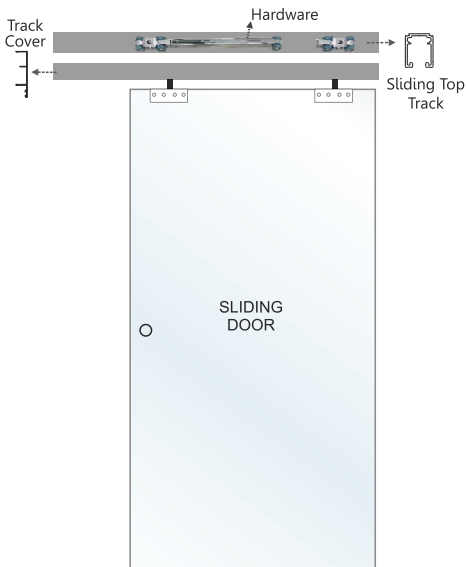

Two Way Soft Close Sliding Hardwares

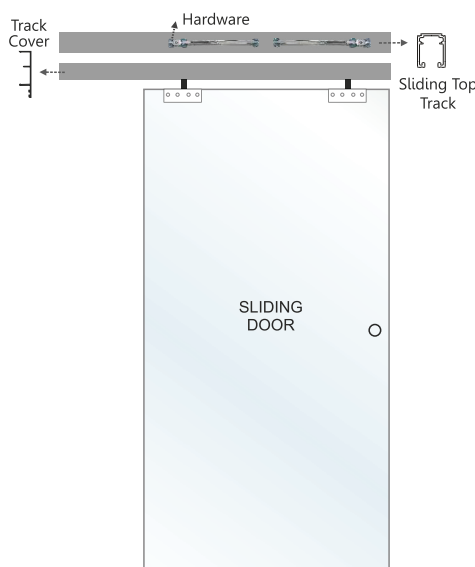

CONFIGURATION

SINGLE DOOR One Side & Two Way SOFT CLOSE

One Side Soft Close Sliding Hardwares

**MAXIMUM WIDTH / HEIGHT
1200 MM / 2400 MM**

**WEIGHT LIMIT PER FRAME
120 KG**

**TRACK COVER FINISH / ANODISED
BLACK MATT / BRUSH GOLD /
CHAMPANGE / ROSE GOLD**

**ALUMINIUM PROFILE SUITABLE FOR
8 MM / 10 MM GLASS**

AVAILABLE WITH LOCK OPTION

TELESCOPIC SOFT CLOSE SLIDING FRAMELESS DOOR



TELESCOPIC GLASS SLIDING SYSTEM
1 FIX + 2 Sliding Door

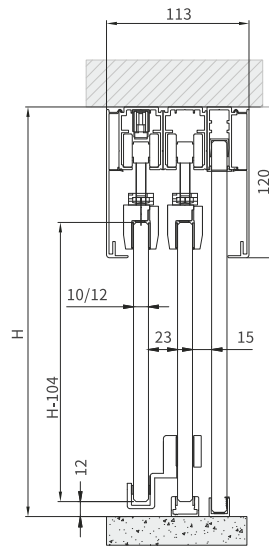
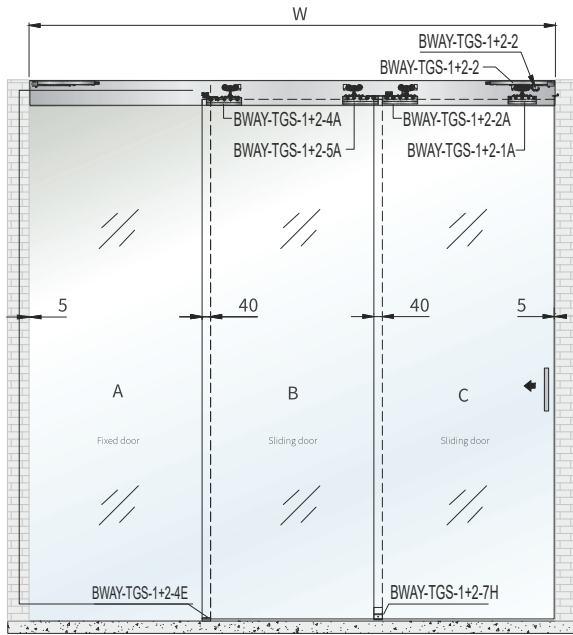

CONFIGURATION
1 FIX + 2 SLIDING DOOR

MAXIMUM WIDTH
1000 MM

WEIGHT LIMIT PER FRAME
120 KG

FINISH
ALUMINIUM ANODISED

MAXIMUM THICKNESS OF GLASS
10 / 12 MM GLASS

AVAILABLE WITH LOCK OPTION

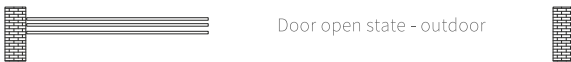

Hardware Fittings



BWAY-TGS-1+2-1A (1PC)



BWAY-TGS-1+2-2A (1PC)



BWAY-TGS-1+2-4A (1PC)



BWAY-TGS-1+2-5A (1PC)



BWAY-TGS-1+2-8A (1PC)



BWAY-TGS-1+2-7H (1PC)



BWAY-TGS-1+2-2 (1PC)



BWAY-TGS-1+2-4C (1PC)



BWAY-TGS-1+2-4E (1PC)



BWAY-TGS-1+2-10 (1PC)

Top Track and Accessories for 3 Panel (1 Fix+2 Doors) BWAY-TGS-Track-Acc (3000mm)

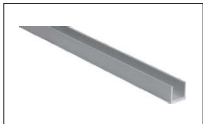

BWAY-TGS-1+2-6-10
Top U Channel (1PC)

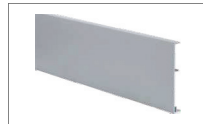

BWAY-TGS-1+2-6-17C (2PC)
Track Cover- MW-3000m



BWAY-TGS-1+2-6-18 CA
U-Channel (1PC)



BWAY-TGS-1+2-6-19C-A
Top Track (2PC)



BWAY-TGS-1+2-20C (1PC)

BWAY-TGS-1+2 (width 3000mm)
TELESCOPIC GLASS SLIDING SYSTEM

TELESCOPIC GLASS SLIDING SYSTEM
1 FIX + 3 Sliding Door

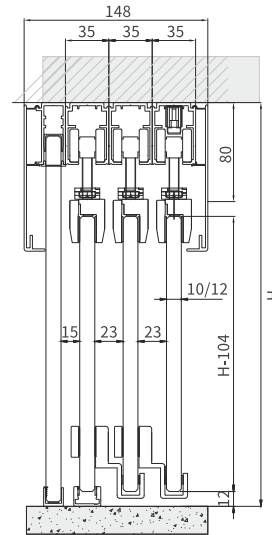
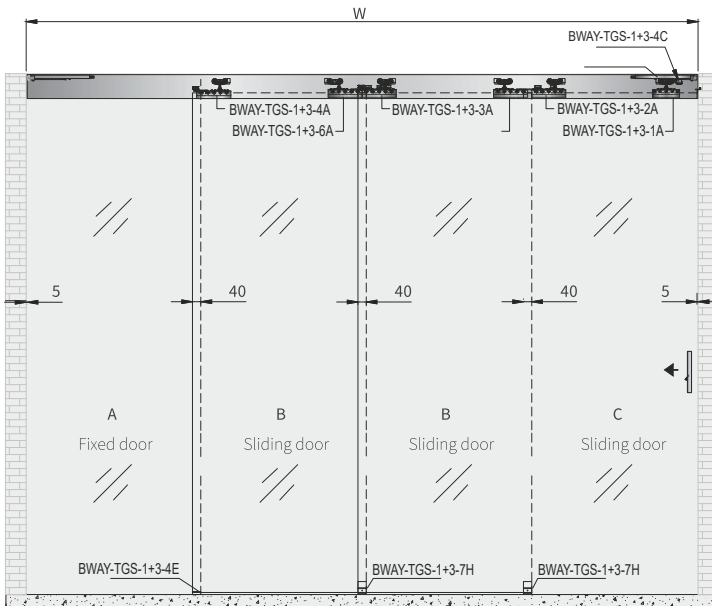

CONFIGURATION
1 FIX + 3 SLIDING DOOR

MAXIMUM WIDTH
1000 MM

WEIGHT LIMIT PER FRAME
120 KG

FINISH
ALUMINIUM ANODISED

MAXIMUM THICKNESS OF GLASS
10 / 12 MM GLASS

AVAILABLE WITH LOCK OPTION

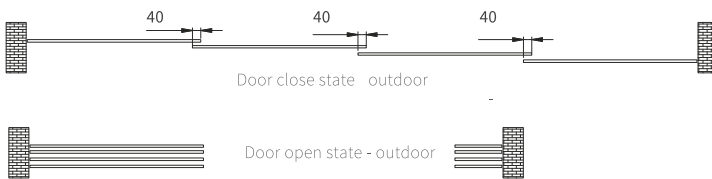

Hardware Fittings



Top Track and Accessories for 4 Panel (1 Fix+3 Doors) BWAY-TGS-Track-Acc (4000mm)



BWAY-TGS-1+3 (width 4000mm)
TELESCOPIC GLASS SLIDING SYSTEM

TELESCOPIC GLASS SLIDING SYSTEM
1 FIX + 4 Sliding Door

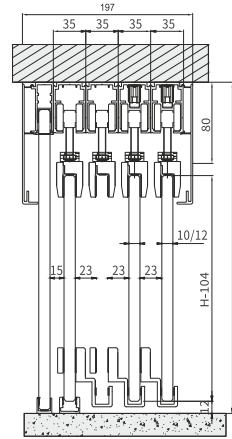
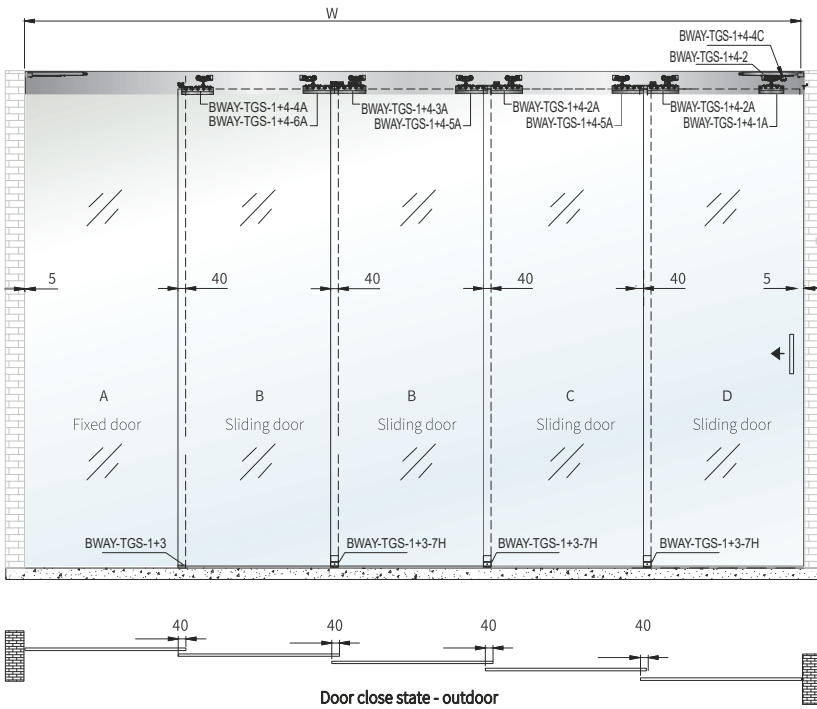

CONFIGURATION
1 FIX + 4 SLIDING DOOR

MAXIMUM WIDTH
1000 MM

WEIGHT LIMIT PER FRAME
120 KG

FINISH
ALUMINIUM ANODISED

MAXIMUM THICKNESS OF
GLASS
10 / 12 MM GLASS

AVAILABLE WITH LOCK
OPTION

Hardware Fittings



Top Track and Accessories for 4 Panel (1 Fix+3 Doors) CSL-TGS-Track-Acc (4000mm)



BWAY-TGS-1+4 (width 5000mm)
TELESCOPIC GLASS SLIDING SYSTEM.

SYNCHRO GLASS SLIDING SYSTEM
2 DOOR SLIDING DOOR

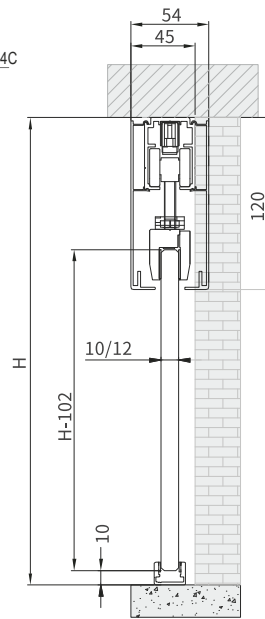
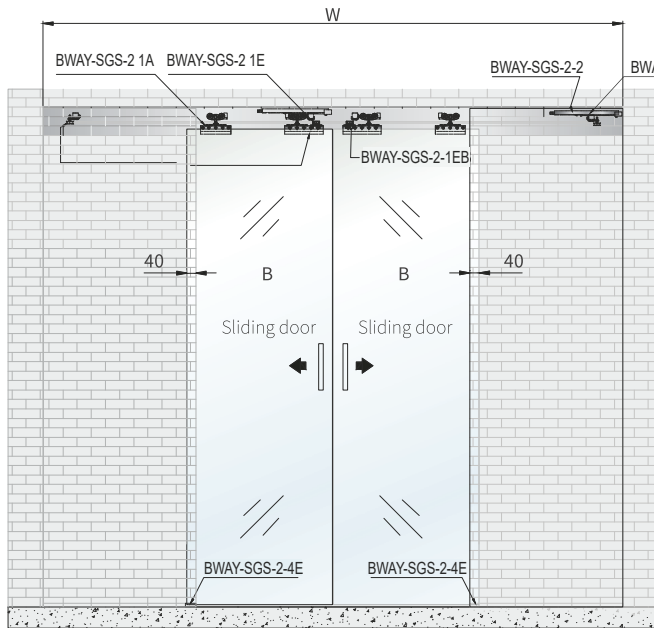

CONFIGURATION
2 SLIDING DOOR

MAXIMUM WIDTH
1000 MM

WEIGHT LIMIT PER FRAME
120 KG

FINISH
ALUMINIUM ANODISED

MAXIMUM THICKNESS OF GLASS
10 / 12 MM GLASS

AVAILABLE WITH LOCK OPTION

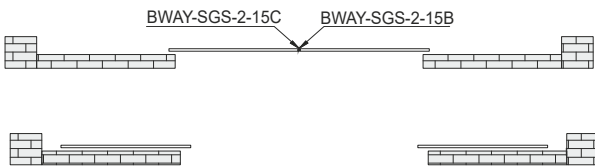

Hardware Fittings



BWAY-SGS-2-1A (2 PCS)



BWAY-SGS-2-10A (2 PCS)



BWAY-SGS-2-1E (1 PC)



BWAY-SGS-2-1EB (1 PC)



BWAY-SGS-2-2E-C (2 PC)



BWAY-SGS-2-4E (2 PCS)



BWAY-SGS-2-4C (2 PCS)

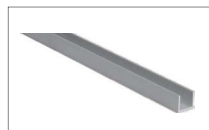

BWAY-SGS-2-6-10 (2 PCS)



BWAY-SGS-2-10 (1 PCS)



BWAY-SGS-2-2 (2 PCS)

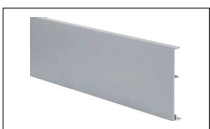

BWAY-SGS-2-17C (2 PCS)
Track Cover- MW-3000m

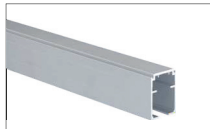

BWAY-SGS-2-19C-A (1 PCS)



BWAY-SGS-2-15B (1 PCS)



BWAY-SGS-2-15C (1 PC)

BWAY-SGS-2 (2 Door)
SYNCHRO GLASS SLIDING SYSTEM

**SYNCHRO GLASS SLIDING SYSTEM
2 FIX + 2 SLIDING DOOR**

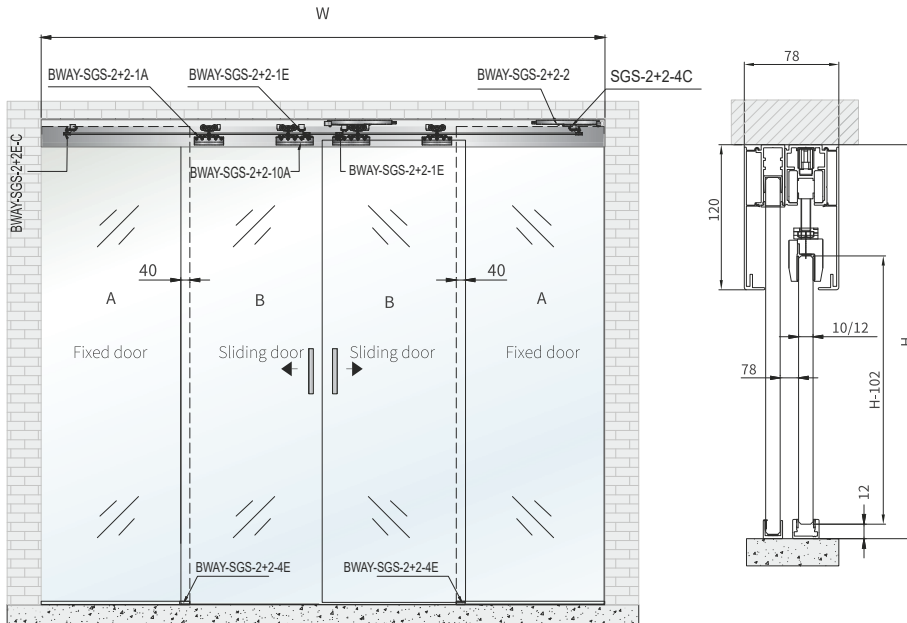

**CONFIGURATION
2 FIX + 2 SLIDING DOOR**

**MAXIMUM WIDTH
1000 MM**

**WEIGHT LIMIT PER FRAME
120 KG**

**FINISH
ALUMINIUM ANODISED**

**MAXIMUM THICKNESS OF GLASS
10 / 12 MM GLASS**

AVAILABLE WITH LOCK OPTION

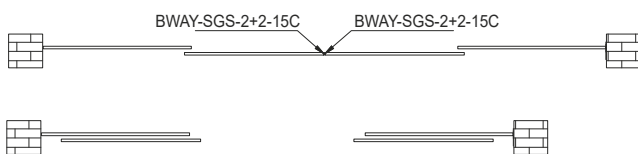

Hardware Fittings

- | | | | | | |
|----------------------------|----------------------------|----------------------------|---------------------------|--------------------------|---|
| | | | | | |
| BWAY-SGS-2+2-1A (2 PCS) | BWAY-SGS-2+2-10A (2 PCS) | BWAY-SGS-2+2-1E (1 PCS) | BWAY-SGS-2+2-1EB (1 PC) | BWAY-SGS-2+2-2E-C (2 PC) | BWAY-SGS-2+2 (2 PCS) |
| | | | | | |
| BWAY-SGS-2+2-4E (2 PCS) | BWAY-SGS-2+2-20C (1 PC) | BWAY-SGS-2+2-4C (2 PC) | BWAY-SGS-2+2-6-10 (2PCS) | BWAY-SGS-2+2-10 (1 PCS) | BWAY-SGS-2+2-17C (2 PCS)
Track Cover- MW-3000m |
| | | | | | |
| BWAY-SGS-2+2-18C-A (1 PCS) | BWAY-SGS-2+2-19C-A (1 PCS) | BWAY-SGS-2+2-3-15B (1 PCS) | BWAY-SGS-2+2-3-15C (1 PC) | | |

**BWAY-SGS-2+2
SYNCHRO GLASS SLIDING SYSTEM**

UltraSlim 36

Office Partition- 25X36 Black Profile



Features

- Profile : 25mm x 36mm
- Can be used for door frame with cover or rebate profile
- Max Partition Height : 3000mm
- Suitable for 8 mm - 12 mm thick glass
- Single Glazing
- Finish Available : Black Matte

Important Information

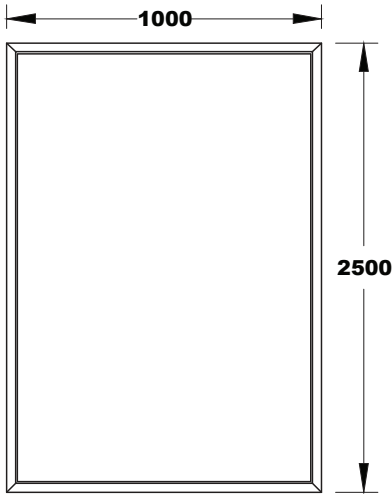

All glass clamping areas are to be cleaned with standard glass cleaning products prior to installation

Do not use thinners

Assembly tool:

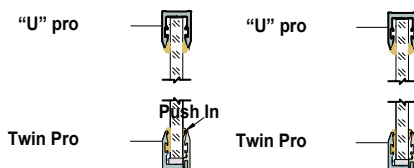
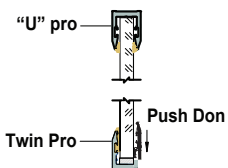
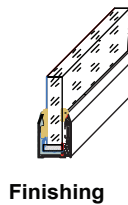
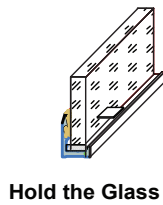
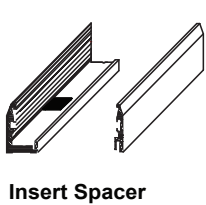
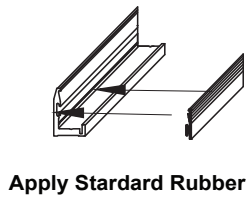
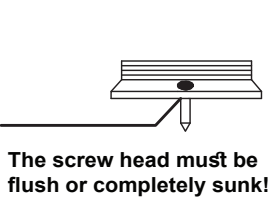
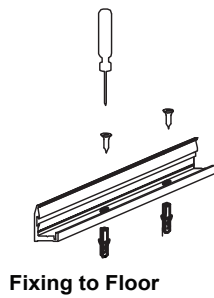
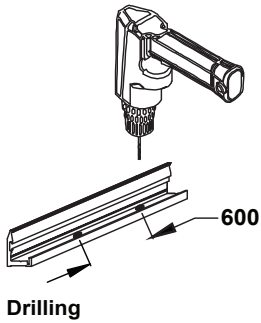
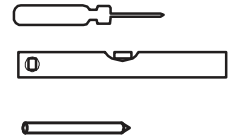
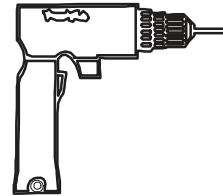

Art.#	Photo	Item Description
TP35.02		U-Pro Single Glazing System
TP35.01		Twin-Pro Single Glazing System
TP.73.57.23.2		Endcap for U-Pro and Twin-Pro in Black Color with Logo.
TP.73.57.23.3		Standard Gasket (EPDM) for U-Pro and Twin-Pro in Black Color
TP.73.57.23.4		Locking Gasket (EPDM) for 12MM Glass Panels
TP.73.57.23.5		Locking Gasket (EPDM) for 10MM Glass Panels
TP.73.57.23.6		Locking Gasket (EPDM) for 08MM Glass Panels
TP.73.57.23.7	 Spacer	3mm PVC Spacer/Shim
TP.73.57.23.8		50mm Stainless Steel Screw with Rawl Plug



TWIN PRO
Leading Technologies

U-PRO



TWIN PRO

Features	Advantages
Unique Profile Design	Simple & faster fabrication and glass Installation Ideal for 8,10 & 12mm glass thickness, 50mm deeper Inner cavity (both Height & Width) permits higher tolerances on glass dimension
Solid Aluminium Profile	Steadfast holding power to structure and for glass
Unique Twinpro Mechanism	No shifting or falling out of position maintenance free
Dry Glazing	Easy installation & demounting as no glue or silicon required easier glass replacement
Minimum Components (2 Profiles & Gaskets)	Reduced inventory multiple applications
Economical	Cost effective time & labour saving by easy installation & faster applied cladding
Aesthetics	Slim & strong design low visual impact space saving
Acoustics	Profile design features and contoured EPDM gaskets helps achieve highest level of sound proofing
Safety & Security / Theft Proof	Deep cavity in profile and uniform grip on all along the 8 edges of glass adds strength to glazing and reduces horizontal movements . Exterior removal of gasket/glass made impossible due to contoured EPDM gasket held under pressure. Better shock absorption.
Color	Available in anodized finishes, mill finish, any RAL colours
Length	Standard size 3600mm, 5800mm (custom sizes available)

Applications:

Glass partitions, interior office partitions with multitude of panel inserts, rail for fixed glass enabling easy assembly, installation and glass replacement, shop fronts with maximum visibility and security, fix windows, partitions that need relocations, frequent assembly and dismantling, photo and mirror frames, elegant signages, much easier to assemble and install, pergolas and sky lights, shower cubicles.



OUTER FRAMED DOOR PARTITION
WITH 45 SERIES IN 6 COLOUR (NEW)



SMART Partition

CONFIGURATION

SWING DOOR WITH PIVOT/HINGE

MAXIMUM WIDTH / HEIGHT

1500 MM / 3600 MM

WEIGHT LIMIT

90 KG

PROFILE FRAME FINISH / ANODISED

BLACK MATT / BRUSH GOLD /
CHAMPAGNE / ROSE GOLD/ DARK
GREY

ALUMINIUM PROFILE SUITABLE FOR

8 MM / 10 MM GLASS

AVAILABLE WITH LOCK OPTION

HEAVY DUTY HINGES



HARDWARE & ACCESSORIES



BWAY-PIVOT-3005
(Capacity 70 kg)



Concealed Hinge
BWAY-Hinge-505(4516)

Black Gold Champagne Dark Grey Rose Gold Bronze



SHOWER DOOR PIVOT
BWAY-PIVOT-3006

Black Gold Champagne Dark Grey Rose Gold Bronze



BUTTERFLY
BWAY-507



BWAY-LJ-90-1351



BWAY-LJ-90-1350

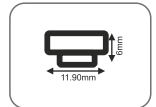

Gasket -
OFF-204-G1350/1351



OUTER FRAMELESS DOOR PARTITION WITH 45 SERIES IN 6 COLOUR (NEW)

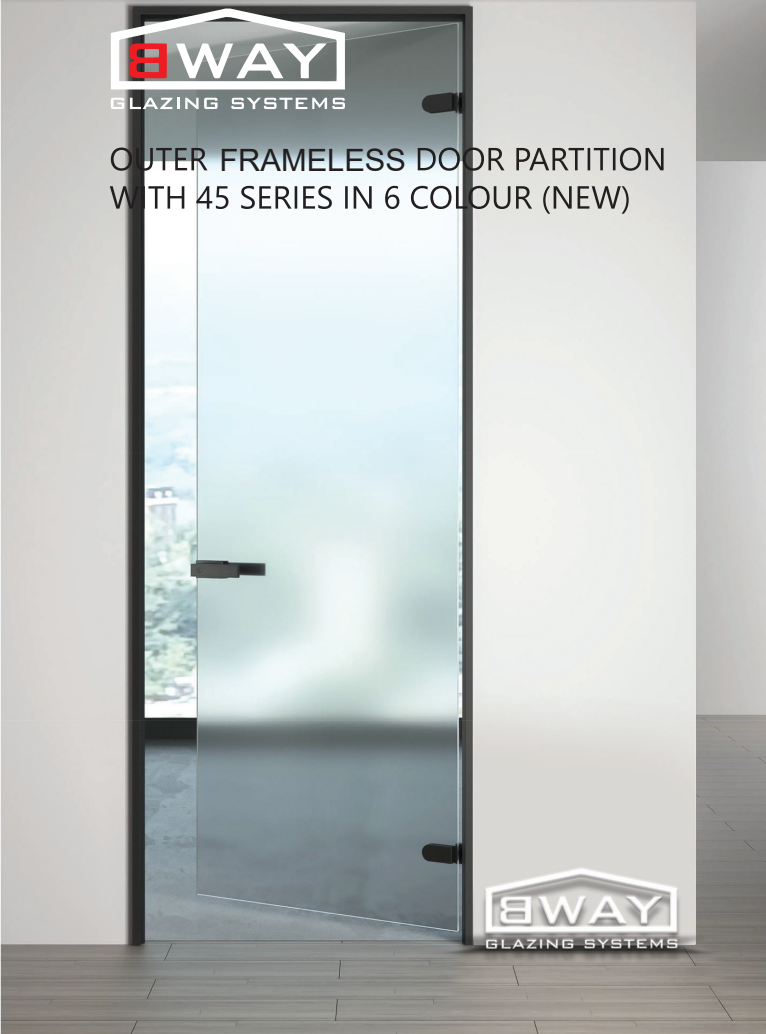

SMART Partition

CONFIGURATION

SWING DOOR WITH PIVOT/HINGE

MAXIMUM WIDTH / HEIGHT

1500 MM / 3600 MM

WEIGHT LIMIT

90 KG

PROFILE FRAME FINISH / ANODISED

BLACK MATT / BRUSH GOLD /
CHAMPAGNE / ROSE GOLD/ DARK
GREY

ALUMINIUM PROFILE SUITABLE FOR

8 MM / 10 MM GLASS

AVAILABLE WITH LOCK OPTION

HEAVY DUTY HINGES

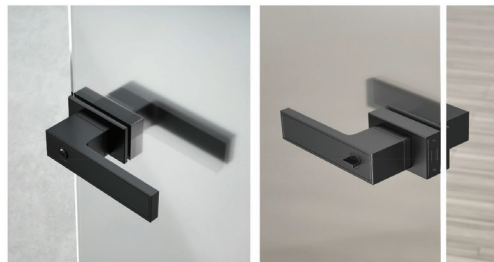
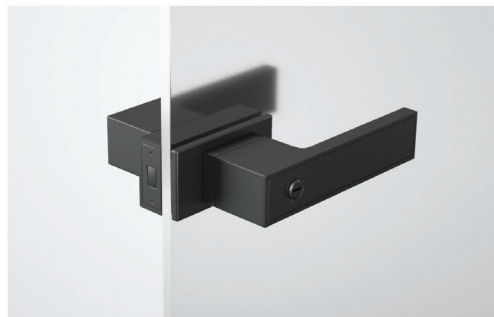

HARDWARE & ACCESSORIES



BWAY-PIVOT-3005
(Capacity 70 kg)



Concealed Hinge
BWAY-Hinge-505(4516)

Black Gold Champagne Dark Grey Rose Gold Bronze



SHOWER DOOR PIVOT
BWAY-PIVOT-3006

Black Gold Champagne Dark Grey Rose Gold Bronze



BUTTERFLY



BWAY-LJ-90-1351



BWAY-LJ-90-1350

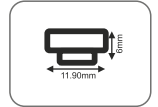

Gasket -
OFF-204-G1350/1351

SMART Sliding & MORE



P.O. Box: 410663, Ras Al Khor, Dubai-UAE

+971 4 580 5525 +971 56 338 9477

✉ dxb@broadwaygcc.com 🌐 www.broadwaygcc.com

NEW BROADWAY
BUILDING MATERIALS LLC
Dubai
+971 4 3333 291
+971 50 425 1456
dxb@broadwaygcc.com

NEW BROADWAY
BUILDING MATERIALS LLC
Ajman
+971 6 7691 155
+971 50 228 7611
ajm@broadwaygcc.com

NEW BROADWAY
BUILDING MATERIALS LLC
Abudhabi
+971 2 550 9290
+971 54 993 1247
auh@broadwaygcc.com

TECHNICAL GLASS &
GLAZING INDIA PVT.LTD.
Kerala - India
+91 7356 921 175
admin@technicalglass.in
www.technicalglass.in

COMFEE TRADING &
CONTRACTING W.L.L.
Doha - Qatar
+974 5590 8399
admin@comfee.biz
www.comfee.biz